

12038ME-48R (0-Type)

General Specifications

Motor Type:

DC Brushless Motor

Motor Protection:

Auto Restart / Polarity Protection (Motor withstands reverse connection for positive and negative leads.)

Insulation Resistance:

10MΩ or over with a DC 500V Megger

Dielectric Withstand Voltage:

AC 500V 1min or AC 700V 1sec

Allowable Ambient Temperature Range:

-10°C ~ + 70°C (Operating)
 -30°C ~ + 70°C (Storage)
 (non-condensing environment)



**For reference only. Please see fan outline for details*

Characteristic Curves

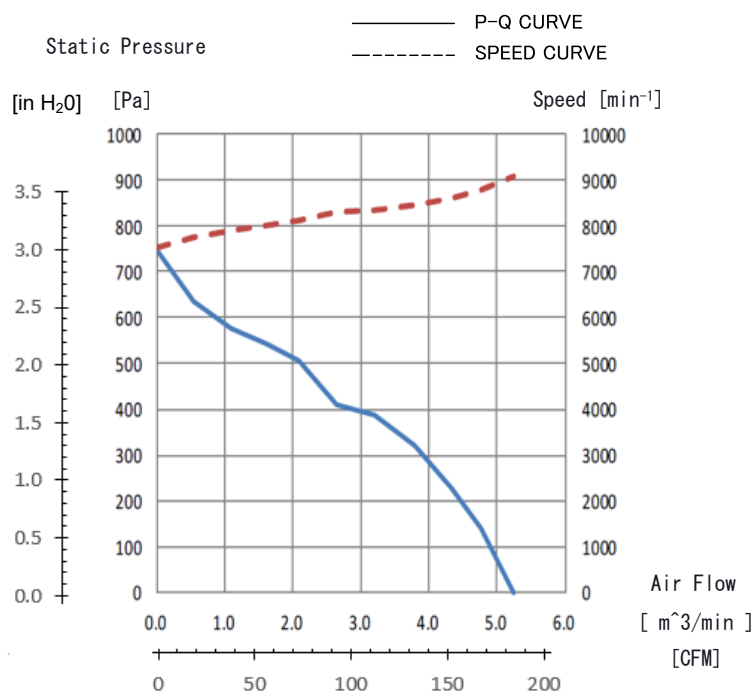

Features

- DC axial fan with outstanding P-Q performance, IP68 protection, PWM speed control, and tach output
- Vertically integrated manufacturing, with key components made in-house
- IP68 with highest level of protection from water/dust ingress and GR-487 salt fog compliant
- Outfitted with NMB precision machined stainless steel ball bearings for long life
- Ideal for applications such as EV chargers, PV inverters, telecom cabinets, small cell 5G network and many other outdoor applications

Life Expectancy L10

40,000 Hours at 40 Celsius

**Fan life expectation is based on free air operation at 40°C, rated voltage, and indoor benign lab environment*

**1: Values in Free Air*

Specifications

MODEL	Rating Voltage	Operating Voltage	Current		Input Power		Speed	Max. Air Flow		Max. Static Pressure		Noise	Mass
	(V)	(V)	Avg (A)*1	Max (A)*1	Avg (W)*1	Max (W)*1		(CFM)	(m ³ /min)	(in H ₂ O)	(Pa)		
	(V)	(V)	(A)*1	(A)*1	(W)*1	(W)*1	(min ⁻¹)*1	(CFM)	(m ³ /min)	(in H ₂ O)	(Pa)	(dB)*1	(g)
12038ME-48R-GK-01	48	38 to 60	0.82	1.10	39.36	52.80	9,000	185	5.25	2.97	740	72	650

PWM Specifications

Connection

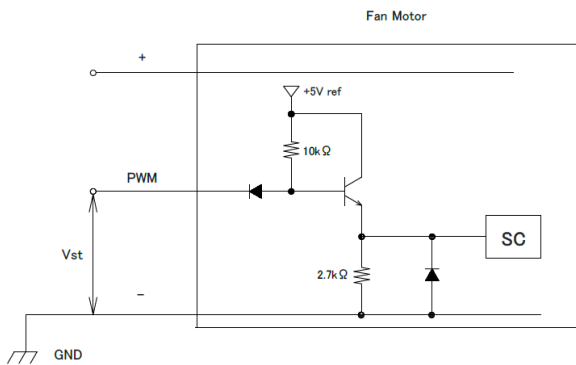

1. PWM Control

- Vst = Low Level (0V~0.8V) → Stop (On Duty 0%)
- Vst = High Level (3.3V~12.0V) → Full Speed (On Duty 100%)
- Vst = Open → Full Speed

2. PWM Duty & PWM Input Pulse

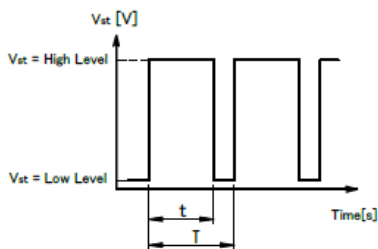

PWM Duty means that a ratio of high level time (t)/PWM Input Pulse(T).

$$(t/T) \times 100 : \text{On Duty } 0\% \sim 100\%$$

$$\text{PWM Frequency } f = 25[\text{kHz}]$$

3. The condition for PWM control are as follows

- When you use this under PWM control, always be sure the motor's operation under practical mounting state. Fan motor may not start up caused by PWM control at very low speed condition.
- To run at Rating Voltage
- Please use the start with Duty 30% or more at 25kHz.[At rated voltage input, Ambient temperature 25°C]

PWM Characteristic Curve

Reference PWM Duty VS Speed
Conditions: at rating Voltage, Vst=5.0V, f=25kHz, Ta=25°C

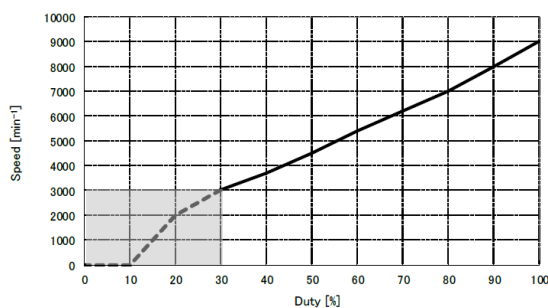

TACHO Specifications

Tachometer Signal

- Output Circuit: Open Collector
- Specification
Absolute Maximum Ratings at Ta=25°C
VCEmax: +60V
ICmax: 5mA[VCE(sat)max=1.0V]

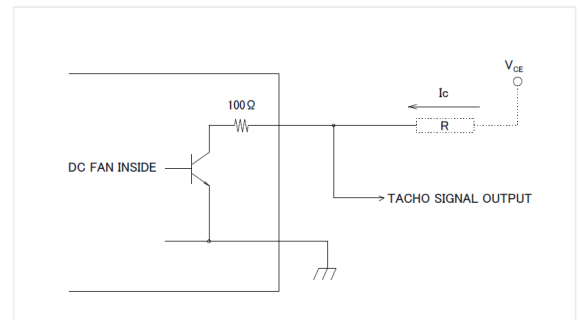

3. Output Waveform: At Rated Voltage Output Signal Voltage

Case-1

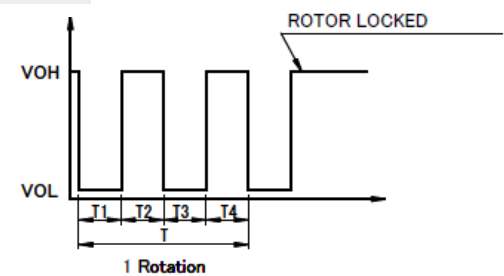

Case-2

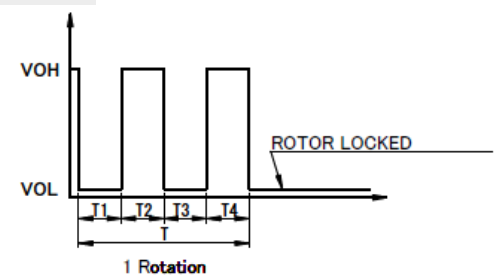

- When the rotor is locked at VOH position of signal, signal keeps VOH position.
- When the rotor is locked at VOL position of signal, signal keeps VOL position.
- $T = T1 + T2 + T3 + T4 = 60/m = 1 \text{ rotation}$

$$m: \text{Fan Speed (min}^{-1}\text{)}$$

$$\text{Tacho Duty Cycle} = 50\% \pm 10\%$$

12038ME-48R (0-Type)

Outlines

(Name Plate)

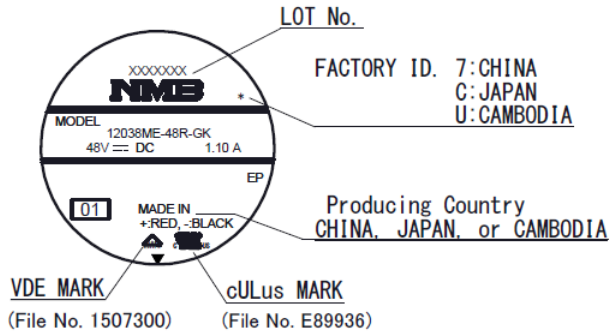

Materials

Casing: Aluminum (Black)

Impeller: Plastic (Black UL 94V-0)

Bearing: Stainless Steel Ball Bearing

Lead Wire: UL3443 AWG24 for

Red (+)

Black (-)

White (Tach)

Brown (PWM)

(Outline)

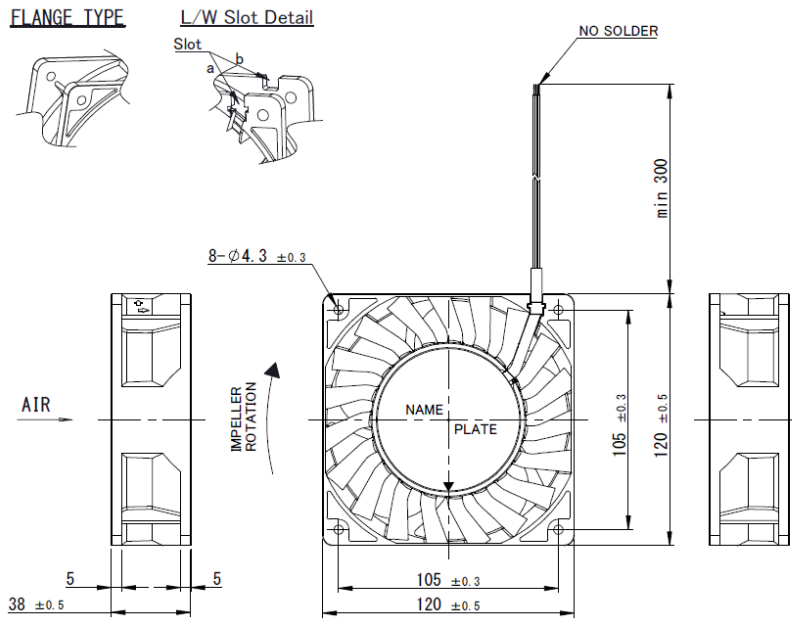

(Panel Out-line)

